



B40 J2

40Ah | 12V | 320A

Electrical Specifications

Nominal voltage	12V
Nominal capacity (20h)	40Ah
CCA (-18°C)	320A
Energy (20h, 25C)	442Wh
Cranking power (10s, -18°C)	2.6kW

Mechanical Specifications

Measurements (L x W x H)	187 x 127 x 225mm
Approx. weight	8.7kg
Base hold-down	B0
Layout / terminals	1 / 3
Polarity	SX
Technology	Flooded
Case material	PP/PE (black)
Lid material	PP/PE (black)

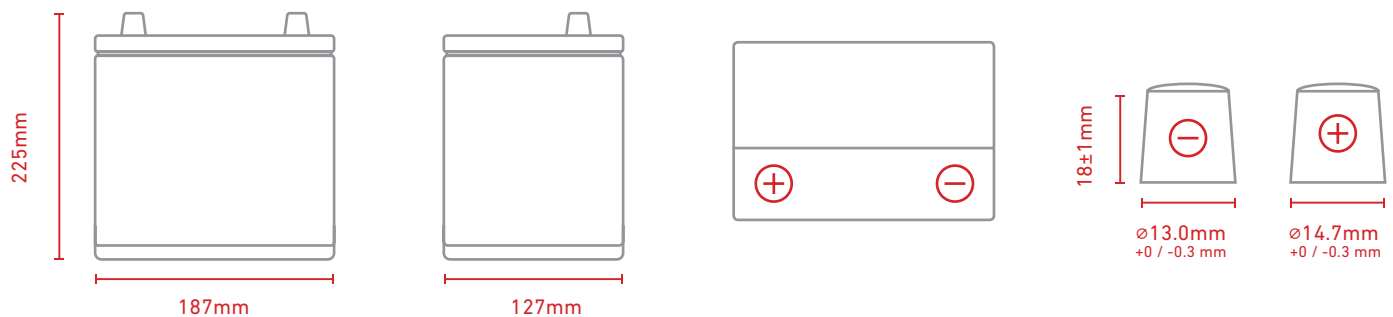

ANTI SPILLING SYSTEM



-18°C TESTED



FLAME ARRESTOR



95% RECYCLABLE



BUILT WITH GREEN ENERGY



MAINTENANCE-FREE

