



P64

64 Ah | 12 V | 630 A

Elektrische Eigenschaften

Nennspannung	12 V
Nennkapazität (25 h)	64 Ah
CCA (-18 °C)	630 A
Leistung (20 h, 25 C)	765 Wh
Anlassleistung (10 s, -18 °C)	4,9 kW

Mechanische Eigenschaften

Maße (L x B x H)	242 x 175 x 190 mm
Gewicht	14,7 kg
Halterung	B3 (f)
Layout / Pole	0 / 1
Polarität	DX
Technologie	Flooded
Gehäusematerial	PP/PE (silber)
Deckelmaterial	PP/PE (silber)

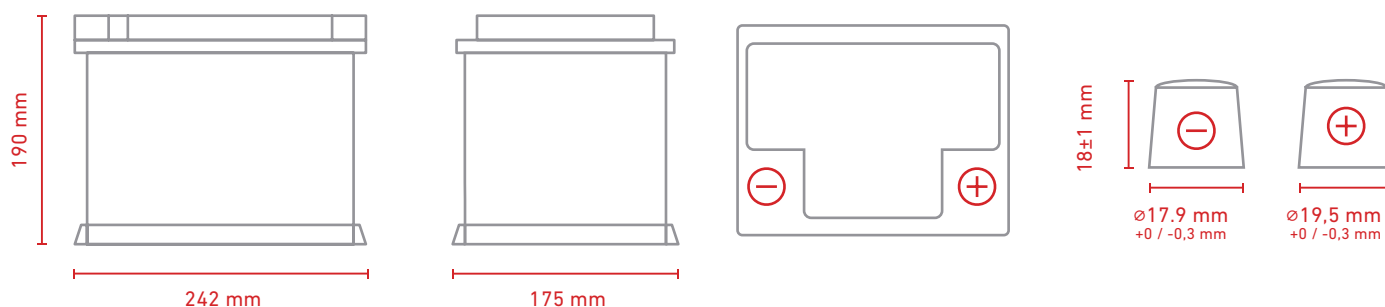

ANTI SPILLING SYSTEM



-18°C TESTED



FLAME ARRESTOR



HIGHER COLD
CRANKING CURRENT



INTERNAL LABYRINTH



MAINTENANCE-FREE



MADE IN EUROPE



95% RECYCLABLE



BUILT WITH GREEN ENERGY

