



SBB 30

Battery Booster
30 A | 45 - 280 Ah | 12 V

Electrical Specifications

Charging mode	MPPT
max. Solar Module Capacity	250Wp
max. Solar Module Current	15A
max. Solar Module Voltage	50V
Battery Nominal Voltage (DC)	12V
Battery nominal capacity	45 - 280Ah
Starter battery nominal capacity min.	60Ah
“Board I” max. charge current solar	20A
“Board I” max. charge current	30A
Input voltage range “Start II”	10,5 - 16V
Input overvoltage disconnection “Start II”, max.	16,5V
Activation control input “D+”	8 - 16V
Signal output “OK/TR”, switch position “TR”, cutoff relay bypass/max	12 V / 1A
“Board I” charging current for “Start II”	0 - 5A
Signal output “OK/TR”, switch position “OK”	12V / 1A
Main battery overvoltage protection	15.5V
Stand-by current	24mA

Mechanical Specifications

Measurements (L x W x H)	194 x 190 x 70mm
Weight	1.33kg
Temperature range	-20 to 50°C
Ambient conditions	max. 95% humidity, no condensation
Optional accessories	Charge monitor, Bluetooth adapter, App display
Input “T T” for battery temperature sensor “Board I”	Yes
“Ss-” “Ss+” inputs for sensor cables “-” and “+” for Battery “Board I”:	Yes

Measurements

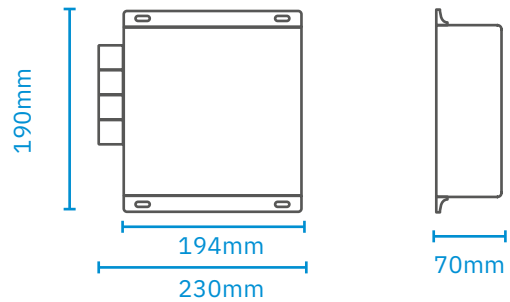

Charging Characteristics

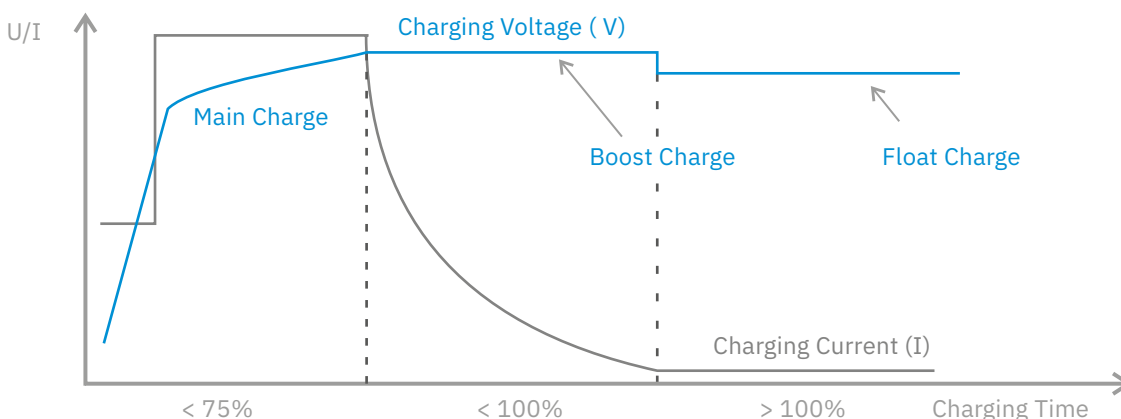

Adjustable for battery types:

- Lead acid
- AGM
- Gel
- LiFePO₄